

Multi-purpose Touch monitor

A Wall mount/ Pole mount/ Arm mount touch monitor
that integratable for any other existing POS/PC device

WTM Series



8.4" Touch monitor
WTM 608



15" Touch minitor
for second display
solution - WTM 550



Cost-effective
POS Solution



Support VESA Standard
and Wall Mounting bracket

Specifications

Model Name	WTM 608	WTM 612	WTM 550	
Display	TFT LCD Size	8.4"	12.1"	15"
	Brightness	250 nits	400 nits	250 nits
	Resolution	800 x 600	800 x 600	1024 x 768
	Touch Screen	5-wire Resistive Type		
I/O Ports	Touch interface	RS-232		1x RS-232 1x USB
	Audio	Audio in jack with 2W Speaker x2		
	VGA	D-SUB 15		
	PS/2	N/A	N/A	1x Mini-DIN
	Wall Mount	Support VESA Standard and wall mounting bracket		
Others	Power Input	External adapter, 60W, 12V DC input		
	Color	Black		
	Compliance	CE / FCC / WEEE / RoHS		CE / FCC / CB/ CCC/ WEEE / RoHS
	Weight	1.4 kgs	2.8 kgs	3.9 kgs
	Dimension WxHxD (mm)	234x185x42	313x256x47	370x310x50.5
	Operating Temperature	0 °C ~ 35 °C		
	Storage Temperature	-20° C~60° C		
	Humidity	20% - 85% RH, non-condensing		

* Please contact supplier for detail information.

Ordering information

Main Unit

Part No.	Description
WTM60-8B-VR	WTM 608 w/ 8.4" VGA Touch Panel, supports RS-232 interface for touch
WTM60-2B-VR	WTM 612 w/ 12.1" VGA Touch Panel, supports RS-232 interface for touch
WTM50-5B-VRU	WTM 550 w/ 15" VGA Touch Panel, supports USB & RS-232 interface for touch

Specifications are subject to change without notice. Issue Date: 2010/11

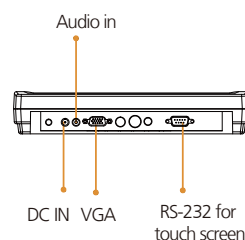
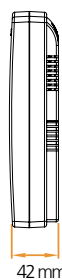
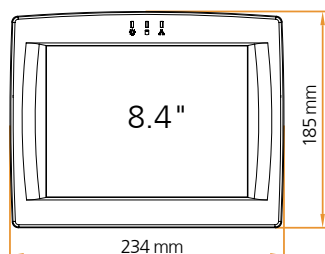
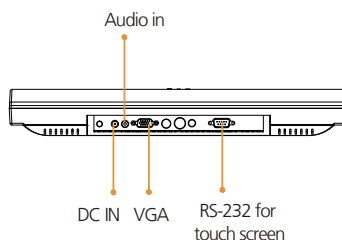
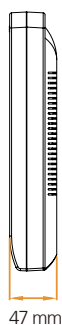
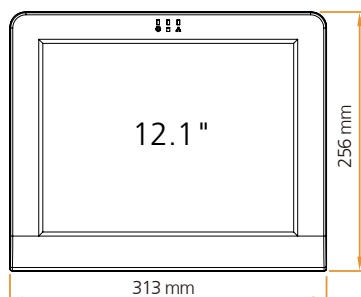
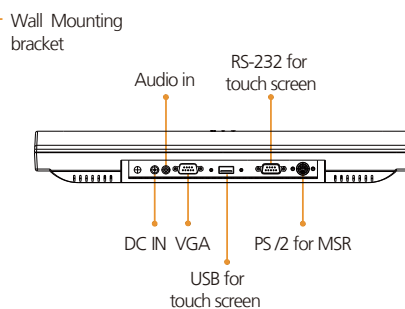
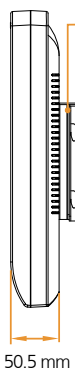
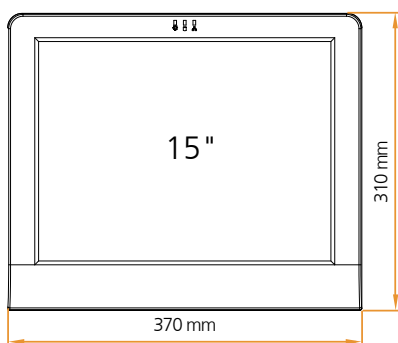

EBN
EBN Technology Corp.

EBN Technology Corp.

10F, No. 90, Sec. 1, Sintai 5th Rd., Sijhih City,
Taipei County 221, Taiwan
TEL : +886-2-2696 9292
FAX : +886-2-2696 9393
E-mail : sales@ebn-pos.com
www.ebn-pos.com